

RONDO
DUO[®]

EXPOSED GRID CEILING SYSTEMS



INSTALLATION GUIDE

RONDO[®]

RONDO DUO

EXPOSED GRID CEILING SYSTEM

INTRODUCTION

Rondo DUO® Exposed Grid Ceiling System is a practical ceiling system which has a complete range of main sections and complementary parts so that you can adapt the modules to suit your design needs.

The DUO® System allows for integration with other Rondo suspended ceiling systems in the same place and is available in both seismic and acoustic designs. It is also able to support acoustic and plasterboard ceiling tiles in non-fire rated environments.

SUITABLE FOR

- Steel Ceiling Grid Systems
- Aluminium Ceiling Grid Systems
- Drop-in Configurations
- One-way semi-concealed configurations
- Acoustic Systems available (by design)
- Seismic Systems available (by design)
- Bulkhead Designs
- Lineal Diffusers

SPECIAL FEATURES

- Available in pre-finished steel
- Double rows of embossed stitching on tees to increase torsional strength
- Able to be removed/reinstalled without damage
- Main tee slots every 100mm for Cross Tees gives extra layout flexibility
- Unique "Zipper" box, better protects and stores product

WHY USE DUO®

The smart design of Rondo DUO® components means they are easily assembled on site, and can be adjusted or replaced without damage. Cross Tees will positively lock into each other through the Main Tee with a gentle push, to create a sturdy structure for your ceiling components.

All components have been designed and tested by Rondo engineers to meet the requirements of suspended ceiling codes in both Australia and New Zealand.

Our DUO® System has been supplied to countless prestigious projects around Australia and the world including the University of South Australia Health Innovation Building, Fiona Stanley Hospital in Perth and RMIT Swanston University in Melbourne.

Note that this brochure is intended to be used as a guide only; full details should be obtained via the Rondo website. Rondo recommends installation by a qualified tradesperson and that you ensure you are referring to the latest version of this guide by comparing it to the one on our website.

VARIOUS RONDO DUO® COMPONENTS



DUO 1



DUO 2

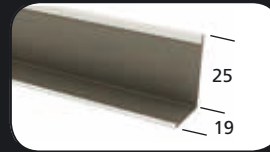

DUO 5

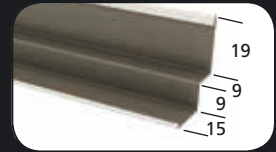

DUO 6

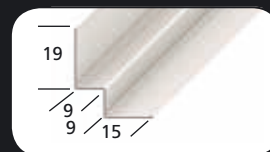

DUO 7

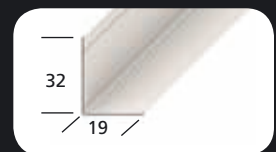

DUO 8



121

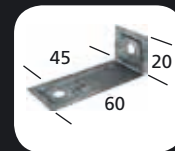

247



274

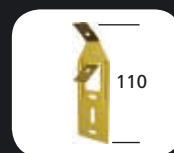

534

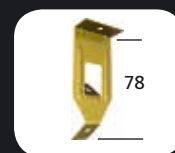

547

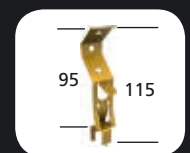

700



703



704*



705



706*



707



708

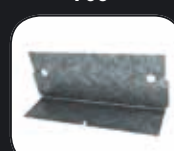

709



716



717

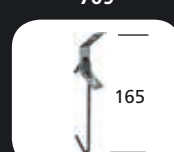

719

* These products are additional DUO® components that are not featured in this guide.

RONDO DUO

TYPICAL APPLICATION DETAILS

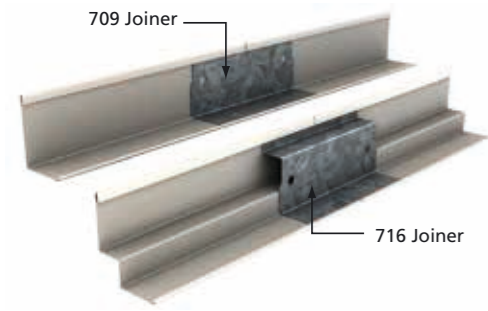

FIGURE 1: WALL ANGLE JOINERS

TABLE 1: TEE SPACING/MAX. ALLOWABLE LOADS

SYSTEM	FACE SIZE mm	SPACING OF M/TS mm	SPACING OF X/TS mm	ALLOWABLE LOAD kg/m ² kg	MAX. WEIGHT OF LIGHT FITTINGS kg	
A	DUO 1-2	24	1200	600	14.2	10
B	DUO 1-2	24	1200	600	14.2	10
C	DUO 1-2	24	1200	600	8.4	6

MAIN TEE	REF	PART NO	LENGTH
	1	DUO 1	3600

CROSS TEE	REF	PART NO	LENGTH
	2	DUO 2	1200
	3	DUO 2	600

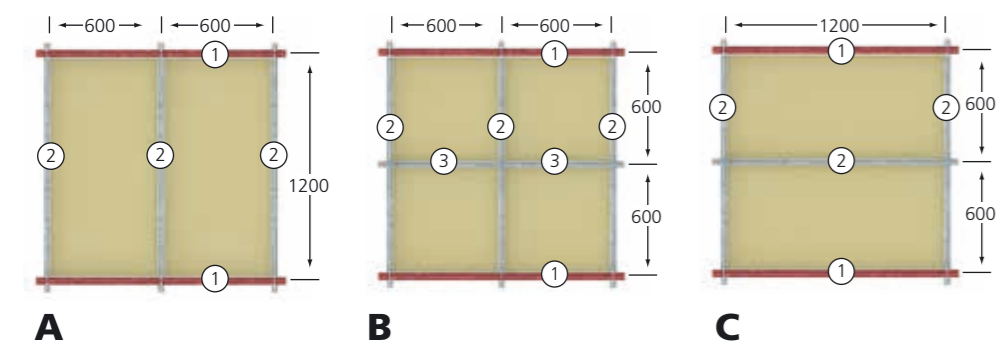

- Select your preferred grid layout to suit either 1200 x 600 or 600 x 600 ceiling panels as shown in Table 1, selecting the relevant cross tee based on the weight of the ceiling tile.
- Set the grid out from the middle of the room to maintain equal cut panels to opposite walls.
- Mark the ceiling height on the walls and fix the perimeter trim with suitable fasteners at max. 600mm centres, ensuring the fixing is made into the studs. Mitre the corner intersections and use joiners to connect angles as per Figure 1.
- Fix the Main Tee suspension brackets as per Figures 2 & 6. Ensure the suspension brackets are installed at no more than 1200mm centres and spaced 1200mm on either side. Ensure the hanger points are set out so that hangers adjacent to the perimeter walls are no more than 300mm from the wall unless otherwise specified.
- Assemble the Main Tee suspension clip to the suspension rods that have been pre-cut to length to suit your suspension drop. Ensure the suspension is vertical.
- Ensure the pre-punched slots on the Main Tee line up, and fit the Main Tee to the clips, as per Figure 4. The Main Tees should now be spaced 1200mm apart and suspended 1200mm between hangers. Stagger joints between adjacent Main Tees.
- Ensure the integrated self locking joiners on Main Tees are properly locked together. Where Main Tees abut the wall trim, secure with the relevant stabiliser clip as per Figure 3.
- Fix Cross Tees into position through the slots in the Main Tee with a gentle push. The opposing cross tees positively lock together as per Figure 5. The slots in the Main Tee are spaced 100mm apart to ensure the correct space is maintained between the Cross Tees (600mm apart for a 1200 x 600 panel). Cross Tees abutting the wall trim should be secured with the relevant clip, as per Figure 3, at not more than 1800mm centres unless otherwise specified.
- Finally, align and level the grid by adjusting the suspension clips up or down using a string line or laser as a guide.

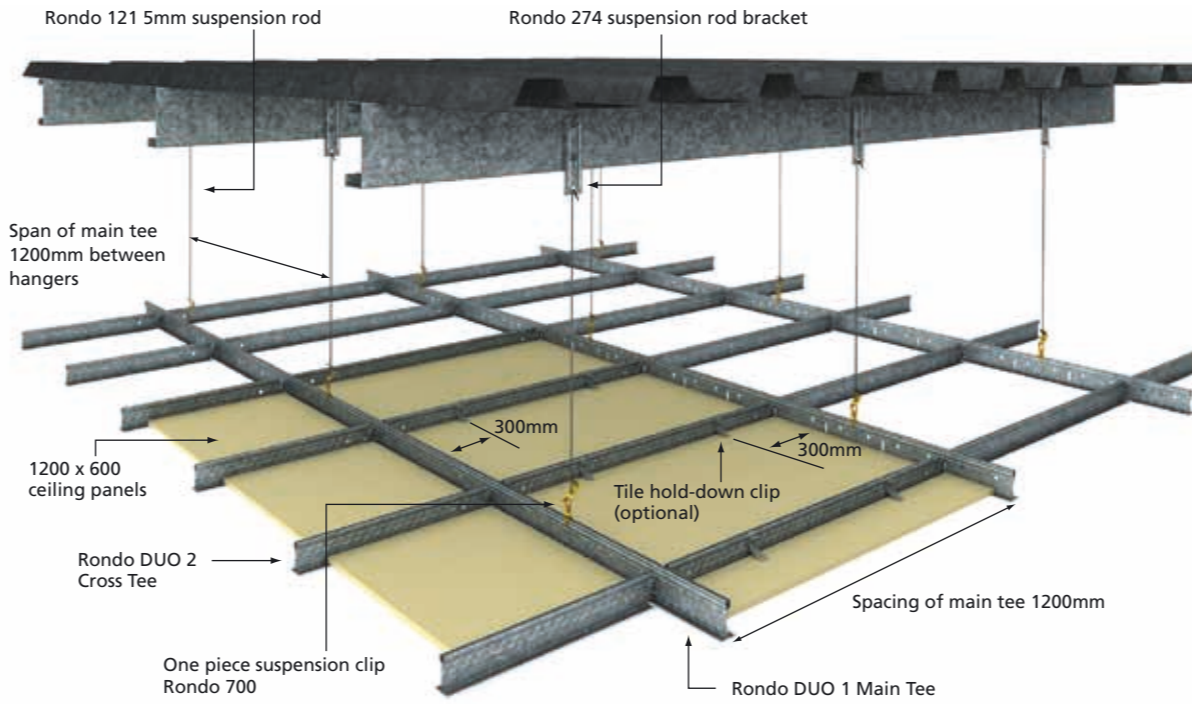

FIGURE 2: TWO-WAY EXPOSED CEILING SYSTEM DETAIL

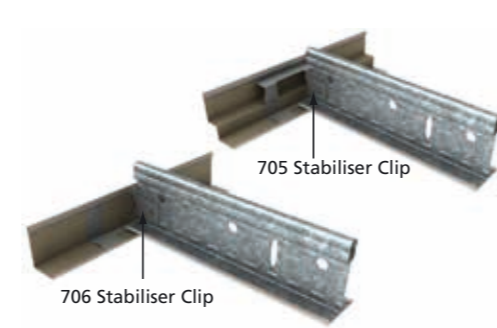

FIGURE 3: STABILISER CLIPS

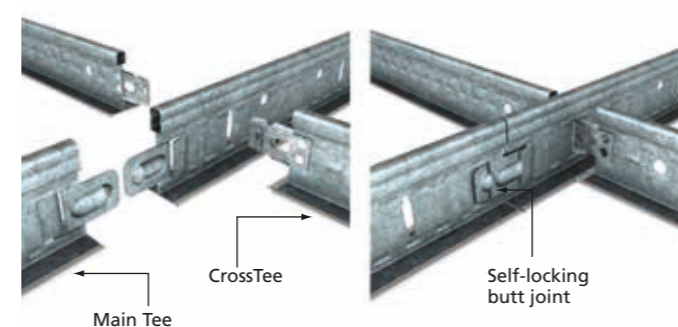

FIGURE 5: MAIN AND CROSS TEE JOINTING CROSS



FIGURE 4: INSTALLING THE RONDO 700 SUSPENSION CLIP



FIGURE 6: ALTERNATIVE SUSPENSION BRACKETS

The installation of troffer type light fittings can be accommodated by installing additional cross tees, but ensuring the weight of the light fitting is borne by the main tees only as in Figure 7.

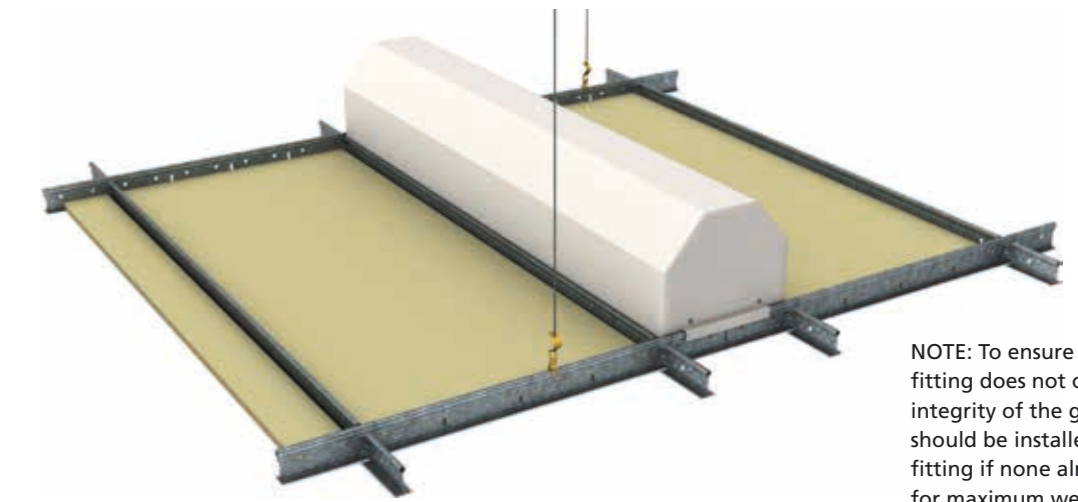

FIGURE 7: LIGHT FITTING DETAIL

NOTE: To ensure the weight of the fitting does not compromise the integrity of the grid, additional hangers should be installed adjacent to the fitting if none already exist. See Table 1 for maximum weight of light fittings.

BULKHEADS

Changes in ceiling levels can be accommodated by the introduction of vertical bulkheads which can be constructed using plasterboard or ceiling panels as shown in Figures 8 & 9. More detailed information on bulkhead construction, or other DUO® applications such as One Way Exposed ceilings, sloping DUO® ceilings, linear diffusers, and securing partition head tracks to grid, is available in the Rondo Professional Design Manual on the Rondo website, www.rondo.com.au.

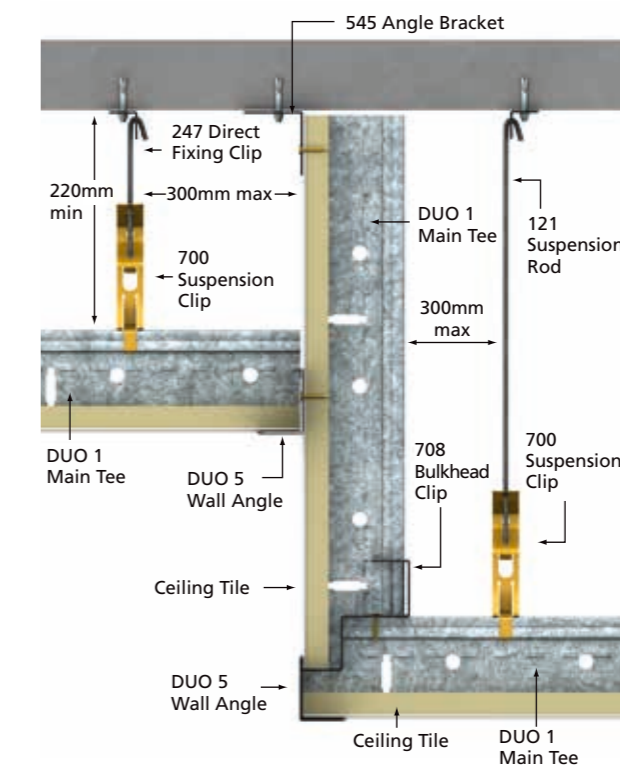

FIGURE 8: SQUARELINE BULKHEAD DETAIL (VERTICAL EXPOSED GRID)

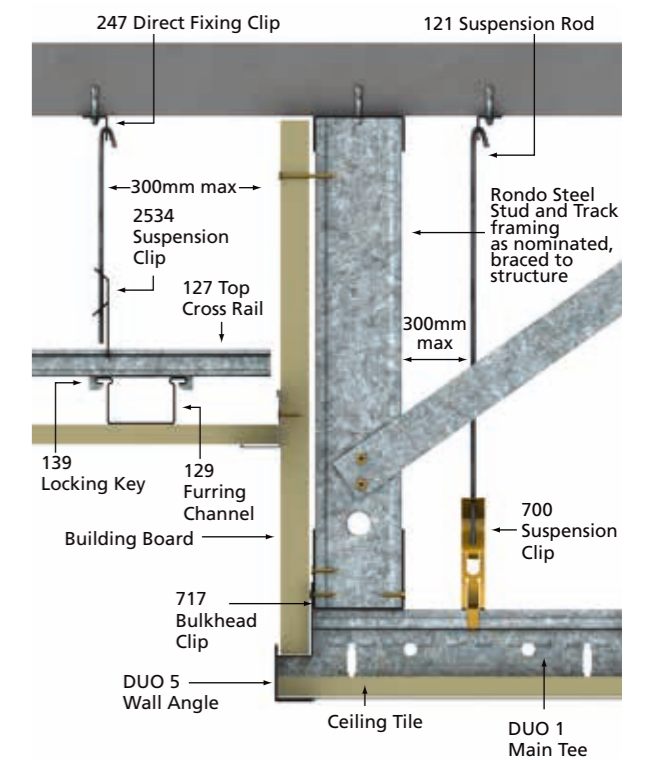

FIGURE 9: SQUARELINE BULKHEAD DETAIL (VERTICAL KEY-LOCK®/STEEL STUD SYSTEM)

RONDO SERVICES

MUCH MORE THAN JUST QUALITY PRODUCTS

We go beyond supplying you with quality products. We give you access to a full suite of tools and services to help you get the job done right and with the confidence that we'll support you every step of the way.

- ✓ **TECHNICAL SUPPORT** We offer expert technical advice from our team of professional Engineers and Technical Representatives who can support you from beginning concepts all the way through to building completion.
- ✓ **WRITTEN WARRANTY** Our products are 100% code compliant and we guarantee that they'll perform to our exacting specifications with a written warranty to give you added peace of mind.
- ✓ **PRODUCT QUALITY** Our state-of-the-art manufacturing technology ensures you receive the highest quality product, with most of our roll-formed products manufactured from the strength of BlueScope Steel.
- ✓ **QUALITY CONTROL** We have a reputation for uncompromising quality and total code compliance. Our certification to internationally recognised, Lloyd's Register Quality Assurance ISO 9001 is evidence of this.
- ✓ **DELIVERY SERVICE** We offer a reliable and efficient delivery service, with products delivered in full and on time whether it is on site or to store.
- ✓ **TECHNICAL RESOURCES** We've developed market-leading technical resources that are available in print and digitally to help you get the job done.
- ✓ **REPUTATION** It's our reputation for high-quality products backed by exceptional customer service that has led to us being behind the best buildings around the world. It's a reputation you can rely on.
- ✓ **ENVIRONMENTAL PERFORMANCE** We can offer you additional Green Points due to our participation in the Environmental Sustainability Charter and our Environmental Management System is accredited to ISO14001.
- ✓ **CORPORATE SOCIAL RESPONSIBILITY** By purchasing your products through Rondo, you are also helping to support the communities in which we give back to including our main partner, Kids Under Cover, who provide safe and comfortable studios for at-risk youth to live in.

RONDO[®]
www.rondo.com.au

RONDO, DUO and KEY-LOCK are registered trademarks of Rondo Building Services Pty Ltd. ABN 69 000 289 207.

First Printed MAY 2009. Revised MAY 2018.